



# AIRCHARGER<sup>®</sup>

## HIGH-FLOW INTAKE KITS

NOT LEGAL FOR SALE OR USE ON ANY POLLUTION CONTROLLED MOTOR VEHICLE IN CALIFORNIA OR STATES ADOPTING CALIFORNIA EMISSION PROCEDURES.  
See knfilters.com for CARB status on each part for a specific vehicle

### INSTALLATION INSTRUCTIONS

**63-1584**

**RAM**

**2019-22 2500/3500**

**V8-6.7L Turbo Diesel**

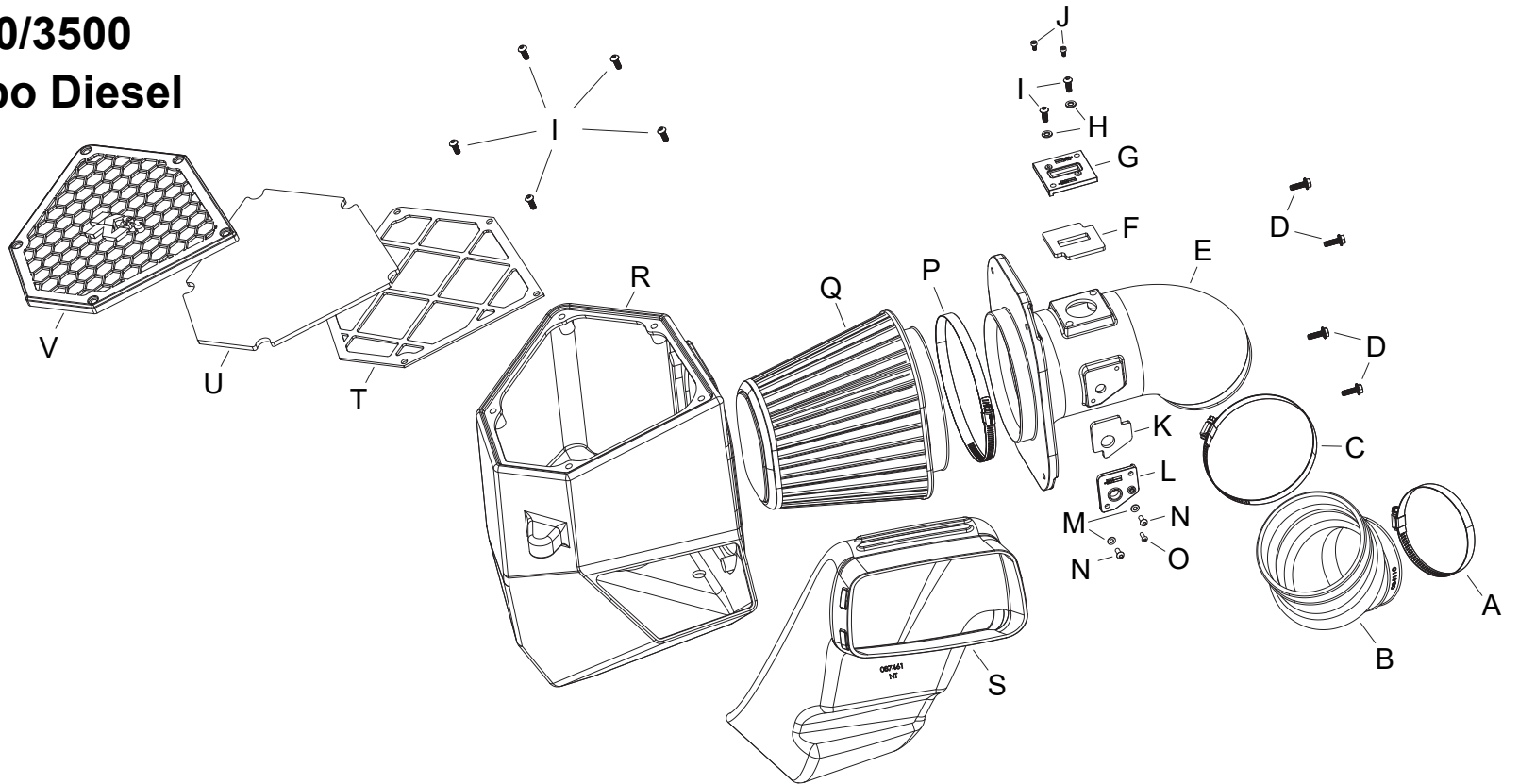

**TOOLS NEEDED:**

- flat blade screw driver
- ratchet
- extension
- 8mm socket
- 10mm socket
- 2.5mm allen key
- 3mm allen key
- 4mm allen key
- t15 torx

**PARTS LIST:**

Description	Qty.	Part #	Description	Qty.	Part #	Description	Qty.	Part #
A HOSE CLAMP #64 STAINLESS	1	08645	H WASHER; 6MM FLAT	2	08269	O SCREW; M4- .7 X 12	1	07726
B HOSE; HUMP 4"OD TO 5"OD	1	084110	I BOLT; M6 X 1 X 16MM	7	07730	P HOSE CLAMP; #104	1	08697
C HOSE CLAMP #80 STAINLESS	1	08685	J BOLT; M4 - .7 X 8MM	2	07733	Q AIR FILTER	1	RU-5292
D BOLT; M6-1 X 20, HEX/FLANGE	4	1-2038	K GASKET; TEMP SENSOR	1	09771	R AIRBOX; (NU)	1	087462
E MAF HOUSING; (NS)	1	087322	L ADAPTER; TEMP SENSOR	1	088021	S AIR DUCT; (NT)	1	087461
F GASKET; 3/16" PORON	1	09069	M WASHER; 5MM FLAT	2	08212	T FRAME; PRECLEANER	1	088073
G ADAPTOR; MAF SENSOR	1	21515-1	N BOLT; M5 X .8 X 12MM	2	07734	U FOAM INSERT	1	971970
						V FRAME; PRECLEANER TOP	1	088072

**If you need any assistance please call 1-800-858-3333 to speak with a representative in our Customer Service Center before returning the product.**

**NOTE: FAILURE TO FOLLOW INSTALLATION INSTRUCTIONS AND NOT USING THE PROVIDED HARDWARE MAY DAMAGE THE INTAKE TUBE, THROTTLE BODY AND ENGINE.**

**TO START:**

1. Turn off the ignition and disconnect the negative battery cable.  
**NOTE: Disconnecting the negative battery cable erases pre-programmed electronic memories. Write down all memory settings before disconnecting the negative battery cable. Some radios will require an anti-theft code to be entered after the battery is reconnected. The anti-theft code is typically supplied with your owner's manual. In the event your vehicles anti-theft code cannot be recovered, contact an authorized dealership to obtain your vehicles anti-theft code.**



2. Remove the 14 push clips that secure the upper core support plastic cover and then remove the cover from the vehicle.



3. Remove the two bolts that secure the fresh air inlet duct to the core support and then remove the inlet from the vehicle.



4. Loosen the hose clamp the secures the intake tube to the air filter housing and disconnect the electrical connections of the two air sensors.



5. Remove the complete air filter housing from the vehicle as shown.  
**NOTE: K&N Engineering, Inc., recommends that customers do not discard factory air intake.**



6. Loosen the hose clamp that secures the factory intake tube to the turbo inlet and then remove the tube from the vehicle.





7. Install the provided gaskets onto the bottom of the two air sensor adapters provided.



8. Remove the air sensors from the factory housing and install them into the K&N® sensor adapters using the provided hardware.



9. Install the two air sensor assemblies into the intake tube using the provided hardware. Be sure the top sensor is installed in the correct direction. The opening of the sensor should be towards the filter end of the tube.



10. Install the flex coupler onto the intake tube and secure with the provided hose clamp. The coupler is keyed and can only be install in one location.



11. Remove the mounting grommets from the factory air filter housing and install them into the K&N® filter housing as shown.



12. Install the K&N® filter housing into the vehicle so the mounting pins protrude through the grommets.



13. Install the tube assembly onto the turbo inlet and into the filter housing. Secure the intake tube with the provided hose clamp and hardware.



14. Reconnect the air sensor electrical connections.

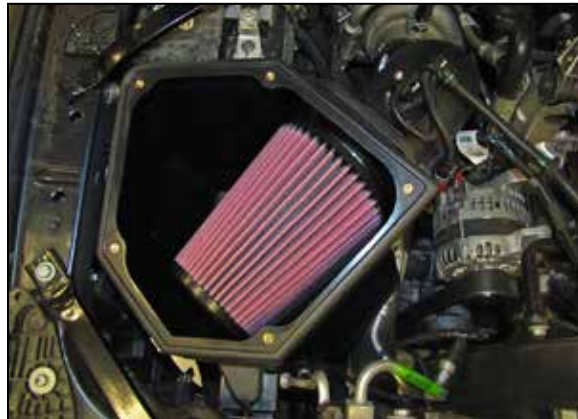

15. Install the K&N® air filter onto the intake tube and secure with the provided hose clamp.



16. Assemble the prefilter lid as shown and then install onto the K&N® air filter housing and secure with the provided hardware.



17. Install the K&N® fresh air intake duct and then install the factory upper portion of the fresh air intake duct and secure with the factory hardware.



18. Reinstall the factory core support cover and secure with the factory retaining clips.



19. Reconnect the vehicle's negative battery cable. Double check to make sure everything is tight and properly positioned before starting the vehicle.

20. It will be necessary for all K&N® high flow intake systems to be checked periodically for realignment, clearance and tightening of all connections. Failure to follow the above instructions or proper maintenance may void warranty.

#### ROAD TESTING:

1. Start the engine with the transmission in neutral or park, and the parking brake engaged. Listen for air leaks or odd noises. For air leaks secure hoses and connections. For odd noises, find cause and repair before proceeding. This kit will function identically to the factory system except for being louder and much more responsive.

2. Test drive the vehicle. Listen for odd noises or rattles and fix as necessary.

3. If road test is fine, you can now enjoy the added power and performance from your kit.

4. K&N Engineering, Inc., requires cleaning the intake system's air filter element every 100,000 miles. When used in dusty or off-road environments, our filters will require cleaning more often. We recommend that you visually inspect your filter once every 25,000 miles to determine if the screen is still visible. When the screen is no longer visible some place on the filter element, it is time to clean it. To clean and re-oil, purchase our filter Recharger® service kit, part number 99-5050 or 99-5000 and follow the easy instructions.

**NOT LEGAL FOR SALE OR USE ON ANY POLLUTION CONTROLLED MOTOR VEHICLE IN CALIFORNIA OR STATES ADOPTING CALIFORNIA EMISSION PROCEDURES.**

See [knfilters.com](http://knfilters.com) for CARB status on each part for a specific vehicle